

INSTALLATION AND USER MANUAL

for your heat pump

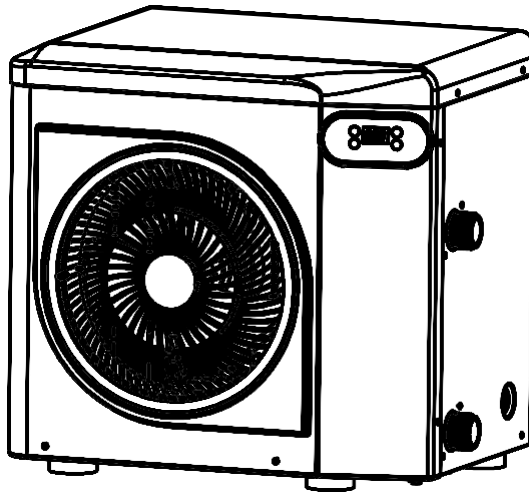

Crystal Mini 40

Warning



This heat pump contains a flammable refrigerant R32.

Any intervention on the refrigerant circuit is prohibited without a valid authorization.

Before working on the refrigerant circuit, the following precautions are necessary for safe work.

1. Work procedure

The work must be carried out according to a controlled procedure, in order to minimize the risk of presence of flammable gases or vapors during the execution of the works.

2. General work area

All persons in the area must be informed of the nature of the work in progress. Avoid working in a confined area. The area around the work area should be divided, secured and special attention should be paid to nearby sources of flame or heat.

3. Verification of the presence of refrigerant

The area should be checked with a suitable refrigerant detector before and during work to ensure that there is no potentially flammable gas. Make sure that the leak detection equipment used is suitable for flammable refrigerants, ie it does not produce sparks, is properly sealed or has internal safety.

4. Presence of fire extinguisher

If hot work is to be performed on the refrigeration equipment or any associated part, appropriate fire extinguishing equipment must be available. Install a dry powder or CO2 fire extinguisher near the work area.

5. No source of flame, heat or spark

It is totally forbidden to use a source of heat, flame or spark in the direct vicinity of one or more parts or pipes containing or having contained a flammable refrigerant. All sources of ignition, including smoking, must be sufficiently far from the place of installation, repair, removal and disposal, during which time a flammable refrigerant may be released into the surrounding area. Before starting work, the environment of the equipment should be checked to ensure that there is no risk of flammability. «No smoking» signs must be posted.

6. Ventilated area

Make sure the area is in the open air or is properly ventilated before working on the system or performing hot work. Some ventilation must be maintained during the duration of the work.

7. Controls of refrigeration equipment

When electrical components are replaced, they must be suitable for the intended purpose and the appropriate specifications. Only the parts of the manufacturer can be used. If in doubt, consult the technical service of the manufacturer.

The following controls should be applied to installations using flammable refrigerants:

- *The size of the load is in accordance with the size of the room in which the rooms containing the refrigerant are installed;*
- *Ventilation and air vents work properly and are not obstructed;*
- *If an indirect refrigeration circuit is used, the secondary circuit must also be checked.*
- *The marking on the equipment remains visible and legible. Illegible marks and signs must be corrected;*
- *Refrigeration pipes or components are installed in a position where they are unlikely to be exposed to a substance that could corrode components containing refrigerant*

8. Verification of electrical appliances

Repair and maintenance of electrical components must include initial safety checks and component inspection procedures. If there is a defect that could compromise safety, no power supply should be connected to the circuit until the problem is resolved.

Initial security checks must include:

- *That the capacitors are discharged: this must be done in a safe way to avoid the possibility of sparks;*
- *No electrical components or wiring are exposed during loading, recovery or purging of the refrigerant gas system;*
- *There is continuity of grounding.*

Thank you

Dear Customer,

Thank you for your purchase and for your confidence in our products.

These are the result of many years of research in the field of design and production of heat pumps for swimming pools. Our aim is to provide you with an exceptional high performance quality product.

We have produced this manual with the utmost care so that you get maximum benefit from your heat pump.

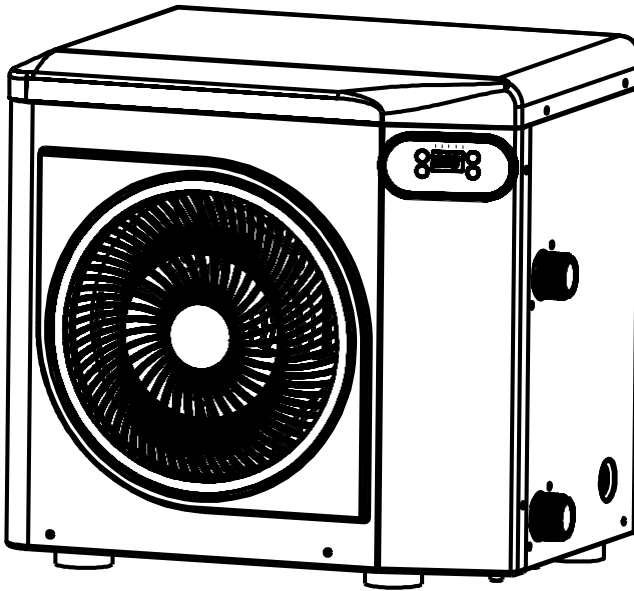



PLEASE READ CAREFULLY

**These installation instructions are an integral part of the product.
They must be given to the installer and retained by the user.**

If the manual is lost, please consult the website:

The instructions and recommendations contained in this manual should be read carefully and understood since they provide valuable information concerning the heat pump's safe handling and operation. **Keep this manual in an accessible place for easy future reference.**

Installation must be carried out by a qualified professional person in accordance with current regulations and the manufacturer's instructions. An installation error may cause physical injury to persons or animals as well as mechanical damage for which the manufacturer can under no circumstances be held responsible.

After unpacking the heat pump, please check the contents in order to report any damage.

Prior to connecting the heat pump, ensure that the information provided in this manual is compatible with the actual installation conditions and does not exceed the maximum limits authorized for this particular product.

In the event of a defect and/or malfunction of the heat pump, the electricity supply must be disconnected and no attempt made to repair the fault.

Repairs must be undertaken only by an authorized technical service organization using original replacement parts. Failure to comply with the above-mentioned clauses may have an adverse effect on the heat pump's safe operation.

To guarantee the heat pump's efficiency and satisfactory operation, it is important to ensure its regular maintenance in accordance with the instructions provided.

If the heat pump is sold or transferred, always make sure that all technical documentation is transmitted with the equipment to the new owner.

This heat pump is designed for heating a swimming pool/Hot Tub or Pond. Any other use must be considered as being inappropriate, incorrect or even hazardous.

Any contractual or non-contractual liability of the manufacturer/distributor shall be deemed null and void for damage caused by installation or operational errors, or due to non-compliance with the instructions provided in this manual or with current installation norms applicable to the equipment covered by this document.

Contents

1. General	6
1.1 General Terms of Delivery	6
1.2 Safety instructions	6
1.3 Water treatment	7
2. Description	8
2.1 Package contents	8
2.2 General characteristics.....	8
2.3 Technical specifications	9
2.4 Unit dimensions	10
2.5 Exploded view.....	11
3. Installation	12
3.1 Location	12
3.2 Installation layout	13
3.3 Hydraulic connection.....	13
3.4 Electrical connection	13
4. Use	14
4.1 Control panel.....	14
4.2 Operating mode selector	14
4.3 Heating Mode	15
4.4 Cooling Mode	16
4.5 Silent Mode.....	17
4.6 Auto Mode	17
4.7 Status values and advanced settings.....	18
5. Operation	20
5.1 Operation.....	20
6. Maintenance and servicing	21
6.1 Maintenance, servicing and winter storage.....	21
7. Repairs	22
7.1 Breakdowns and faults.....	22
7.2 List of faults.	23
8. Recycling	24
8.1 Recycling the heat pump.....	24
A. Appendices	25
A.1 Wiring diagrams.....	25

1. General

1. General Terms of Delivery

All equipment, even if shipped 'free of carriage and packing', is dispatched at the consignee's own risk.

The person responsible for receiving the equipment must carry out a visual inspection to identify any damage to the heat pump during transport (refrigerant system, body panels, electrical control box, frame). He/she must note down on the carrier's delivery note any remarks concerning damage caused during transport and confirm them to the carrier by registered letter within 48 hours.

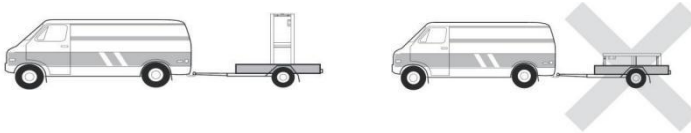

The equipment must always be stored and transported vertically on a pallet and in its original packaging. If it is stored or transported horizontally, wait at least 24 hours before switching it on.

1. Safety instructions



WARNING : Please read carefully the safety instructions before using the equipment. The following instructions are essential for safety so please strictly comply with them.

During installation and servicing

Only a qualified person may undertake installation, start-up, servicing and repairs, in compliance with current standards.

Before operating or undertaking any work on the equipment (installation, commissioning, usage, servicing), the person responsible must be aware of all the instructions in the heat pump's installation manual as well as the technical specifications

Under no circumstances install the equipment close to a source of heat, combustible materials or a building's air intake.

If installation is not in a location with restricted access, a heat pump protective grille must be fitted

To avoid severe burns, do not walk on pipework during installation, repairs or maintenance.

To avoid severe burns, prior to any work on the refrigerant system, turn off the heat pump and wait several minutes before placing temperature and pressure sensors.

Check the refrigerant level when servicing the heat pump.

Check that the high and low pressure switches are correctly connected to the refrigerant system and that they turn off the electrical circuit if tripped during the equipment's annual leakage inspection.

Check that there is no trace of corrosion or oil stains around the refrigerant components.

1. General

During use

To avoid serious injuries, never touch the fan when it is operating.

Keep the heat pump out of the reach of children to avoid serious injuries caused by the heat exchanger's blades.

Never start the equipment if there is no water in the pool or if the circulating pump is stopped.

Check the water flow rate every month and clean the filter if necessary.

During cleaning

Switch off the equipment's electricity supply.

Close the water inlet and outlet valves.

Do not insert anything into the air or water intakes or outlets.

Do not rinse the equipment with water

Rinse only the titanium with water

During repairs

Carry out work on the refrigerant system in accordance with current safety regulations.

Brazing should be performed by a qualified welder.

When replacing a defective refrigerant component, use only parts certified by our technical department.

When replacing pipework, only copper pipes conforming to Standard NF EN12735-1 may be used for repairs.

When pressure-testing to detect leaks:

To avoid the risks of fire or explosion, never use oxygen or dry air.

Use dehydrated nitrogen or a mixture of nitrogen and refrigerant.

The low and high side test pressure must not exceed 42 bar.

1.3 Water treatment

Heat pumps for swimming pools can be used with all types of water treatment systems. Nevertheless, it is essential that the treatment system (chlorine, pH, bromine and/or salt chlorinator metering pumps) is installed after the heat pump in the hydraulic circuit.

To avoid any deterioration to the heat pump, the water's pH must be maintained between 6.9 and 8.0.

2. Description

2. Package contents

- ✓ Crystal Heat pump - Mini 40 Turbo R32
- ✓ 2 hydraulic inlet/outlet connectors 32/38mm diameter
- ✓ This installation and user manual
- ✓ **4 anti-vibration pads**

2. General characteristics

A heat pump has the following features:

- ◆ CE certification and complies with the RoHS European directive
- ◆ High performance with up to 90% energy savings compared to a conventional heating system.
- ◆ Clean, efficient and environmentally friendly R32 refrigerant
- ◆ Reliable high output leading brand compressor.
- ◆ Wide hydrophilic aluminum evaporator for use at low temperatures.
- ◆ User-friendly intuitive control panel.
- ◆ Heavy duty shell, anti-UV treated and easy to maintain.
- ◆ Designed to be silent.

2. Description

2. Technical specification

		Crystal Mini 40
Advised pool volume	m³	20-25
Heating temperature range	°C	25-45
Cooling temperature range	°C	5-28
Auto mode temperature range	°C	5-43
Operating range	°C	-20-43
Air 26°C Water 26°C	capacity (KW)	4.25-2.10
	power input(KW)	0.73-0.18
	Current value (A)	3.24-0.79
	COP	11.60-5.82
Air 15°C Water 26°C	capacity (KW)	3.15-1.22
	power input(KW)	0.75-0.18
	Current value (A)	3.26-0.79
	COP	6.75-4.20
Air 35°C Water 27°C	capacity (KW)	2.58-0.85
	power input(KW)	0.75-0.68
	Current value (A)	3.26-0.21
	EER	4.05-3.44
Air -15°C Water 26°C	Capacity(KW)	1.42-0.55
	Power input(KW)	0.713-0.171
	Input current(A)	3.087-0.743
	COP	3.22-1.99
Air -20°C Water 26°C	Capacity(KW)	0.79-0.31
	Power input(KW)	0.675-0.162
	Input current(A)	2.913-0.704
	COP	1.91-1.17
power supply		220-240V / ~/50Hz
max power input	KW	1.5
max current	A	6.65
water flow-Min/Max	m³/h	0.9/3.6
Refrigerant volume		R32/0.30kg
Min pressure/max pressure		1.5/4.15MPa
unit net dimensions(mm)		400x280x385
package dimensions(mm)		460x370x415
net weight kg		20
gross weight kg		22
noise at 10m		<35 dB(A)
compressor brand		GMCC
Condenser type		Titanium Tube
water proof level		IPX4
Loss charge (mCE)		0.8

The technical specifications of our heat pumps are provided for information purposes only. We reserve the right to make changes without prior notice.

2. Description

2. Unit dimensions

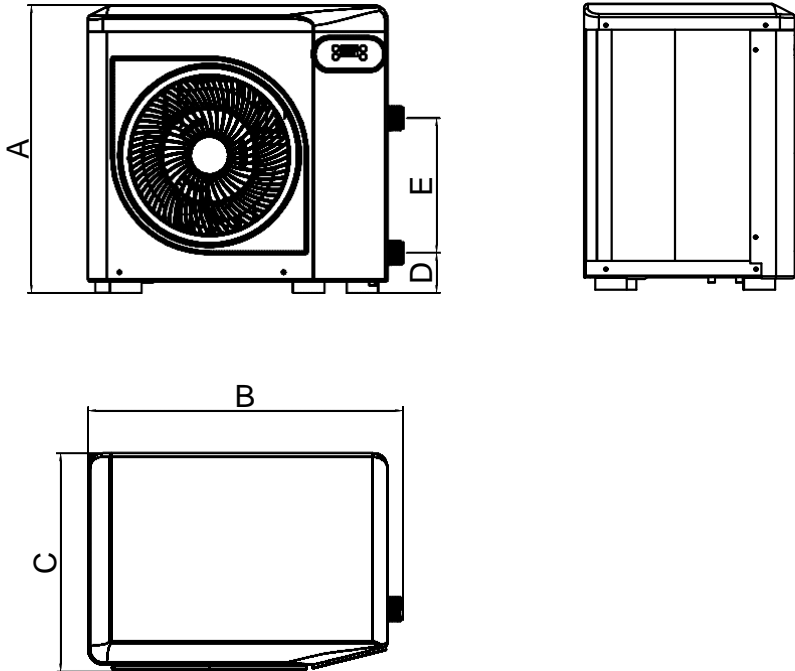

Dimensions in mm

	Crystal Mini 40
A	385
B	420
C	290
D	52
E	180

2. Description

2.5 Exploding view

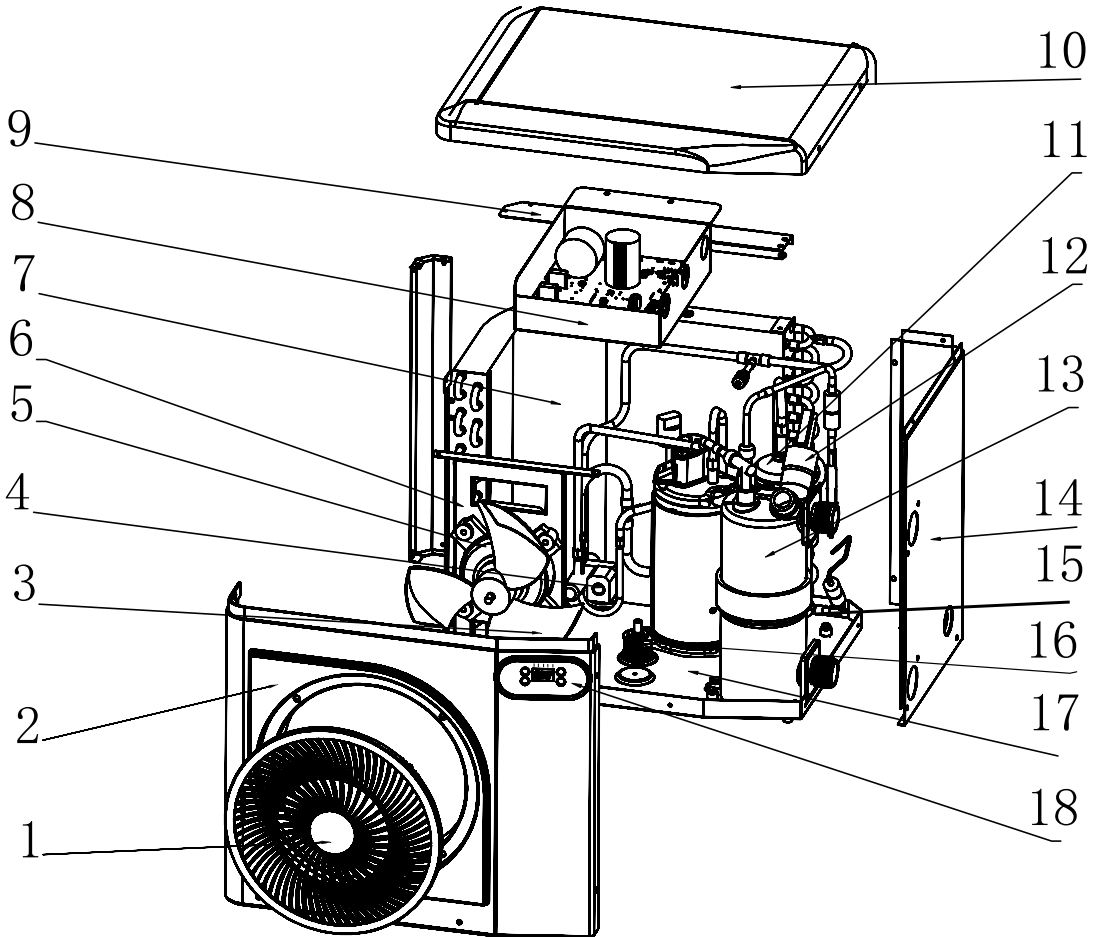

1. Fan protective grille
2. Front panel
3. Fan blade
4. 4-way valve
5. Fan motor
6. Fan support
7. Evaporator
8. Electrical control box
9. Mounting frame

10. Top panel
11. Compressor
12. Water Flow Switch
13. Heat exchanger
14. Left side panel
15. Electric base frame heating
16. Electric crankshaft heating
17. Base frame
18. Control panel

3. Installation

The heat pump is very easy to install, only water and power need to be connected during installation.

3. Location

The heat pump should be located at least 2.5 meter away from the swimming pool.

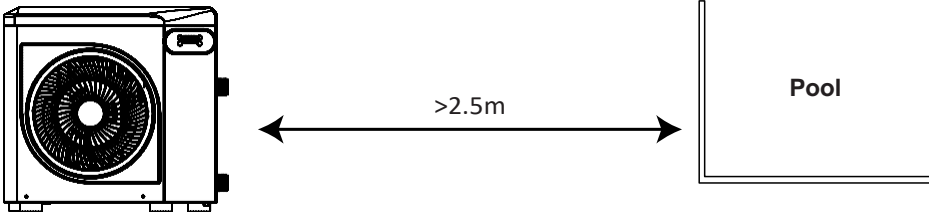

Please comply with the following rules concerning the choice of heat pump location.

1. The unit's future location must be easily accessible for convenient operation and maintenance.
2. It must be installed on the ground, laid ideally on a level concrete base . Ensure that the floor is sufficiently stable and can support the weight of the unit
3. Check that the unit is properly ventilated, that the air outlet is not facing the windows of neighboring buildings and that the exhaust air cannot return. In addition, provide sufficient space around the unit for servicing and maintenance operations.
4. The unit must not be installed in an area exposed to oil, flammable gases, corrosive products, sulfurous compounds or close to high frequency equipment.
5. To prevent mud splashes, do not install the unit near a road or track.
6. To avoid causing nuisance to neighbors, make sure the unit is installed so that it is positioned towards the area that is least sensitive to noise.
7. Keep the unit as much as possible out of the reach of children.

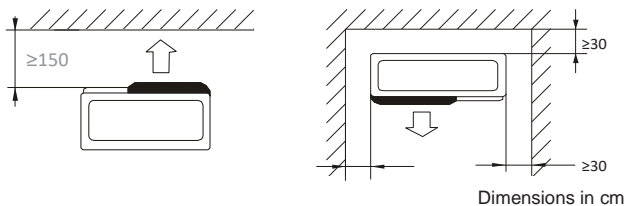

Place nothing less than 1,50 m in front of the heat pump.

Leave 30 cm of empty space around the sides and rear of the heat pump.

Do not leave any obstacle above or in front of the unit!

3. Installation

3. Installation layout

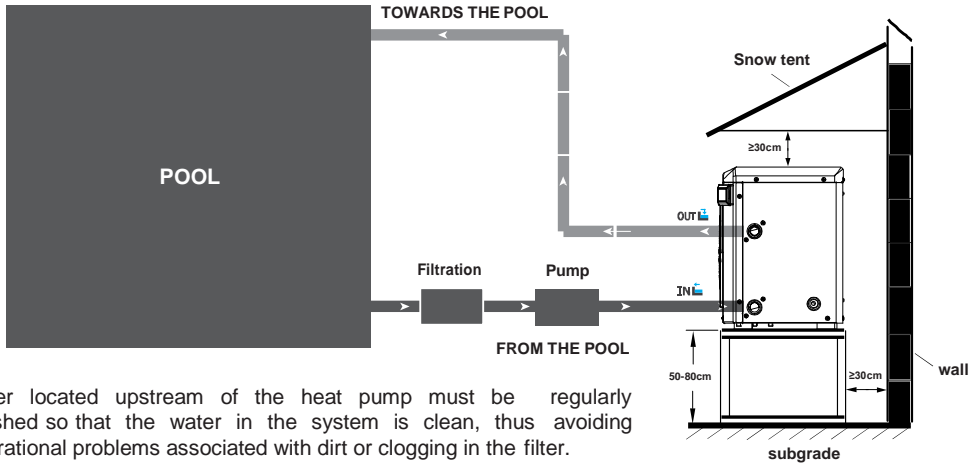

The filter located upstream of the heat pump must be regularly backwashed so that the water in the system is clean, thus avoiding the operational problems associated with dirt or clogging in the filter.

3. Hydraulic connection

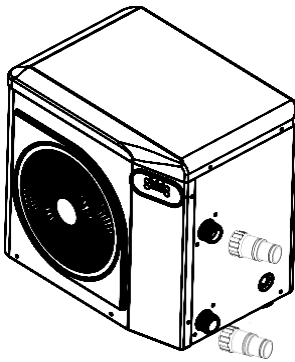

Step 1
Screw the connectors to the heat pump

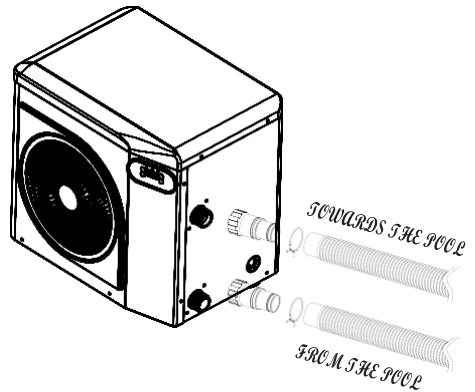

Step 2
Connect the water outlet pipe and the water intake pipe

3. Electrical connection

The heat pump electrical plug integrates a 10mA differential circuit breaker. Before connecting your heat pump, please ensure that the plug is connected to the ground.

The filter pump should function at the same time as the heat pump. Therefore, you need to connect them to the same electrical circuit.

Model	max current (A)	maximum length of the wire(m)						Refrigerant
		1.0mm ²	1.5mm ²	2.5mm ²	4mm ²	6mm ²	10mm ²	
Crystal Mini 40	6.65	36	52	88	142	213	371	R32

4. Use

4.1 Control panel

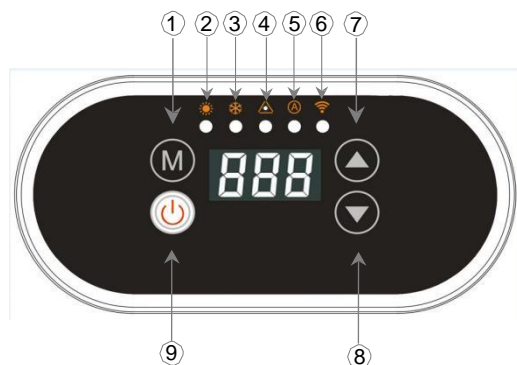

1. Mode button
2. Heating mode indicator
3. Cooling/Defrost mode indicator
4. Silent mode indicator
5. Auto mode indicator
6. Wifi indicator
7. Increase Temp. button
8. Decrease Temp. button
9. ON/OFF button

4.2 Operating mode selector



Before starting, ensure that the filtration pump is working and that water is circulating through the heat pump.

Prior to setting your required temperature, you must first select an operating mode for your control panel:



Heating Mode

Select the heating mode for the heat pump to heat the water in your pool.



Cooling Mode

Select the cooling mode for the heat pump to cool the water in your pool.



Silent Mode

Select the heating mode for the heat pump to heat the water in your pool.



Auto Mode

automatic cooling or heating according to the set temperature.





Wifi

Wifi function enabled

4. Use

4.3 Heating Mode

Step 1 : Press  to switch on your pump.

Step 2 : Press  to switch from one mode to another until the heating mode is displayed.

Step 3 : Using buttons  and  select the required temperature. EXAMPLE:

If the current temperature is 18.8°C, default setting temperature is 27°required temperature is 30° C.



Current water temperature



Required water temperature

Useful information about how the heating mode operates

When the incoming water temperature is less than or equal to the required temperature (set point temperature) -X°C, the heat pump will switch to heating mode. The compressor will stop when the temperature of the incoming water is greater than or equal to the required temperature (set point temperature).

Temperature deviation value X setting

X : adjustable parameter from 1° to 18°C, default setting of temperature deviation value is 1°C. (Parameter "P01")

4. Use

4.4 Cooling mode

Step 1 : Press  to switch on your pump.

Step 2 : Press  to switch from one mode to another until the cooling mode is displayed.

Step 3 : Using buttons  and  select the required temperature.

EXAMPLE :

If the current temperature is 30°C, default setting temperature is 27° required temperature is 15°C.



Current water temperature



Required water temperature

Useful information about how the cooling mode operates

When the incoming water temperature is greater than or equal to the required temperature (set point temperature) - X°C, the compressor will switch to cooling mode. The compressor will stop when the temperature of the incoming water is less than or equal to the required temperature (set point temperature).

Temperature deviation value X setting

X : adjustable parameter from 1° to 18°C, default setting of temperature deviation value is 1°C. (Parameter "P01")

4. Use

4.5 Silent mode

Step 1 : Press  to switch on your pump.

Step 2 : Press  to switch from one mode to another until the silent mode is displayed.

Step 3 : Using buttons  and  select the required temperature.

EXAMPLE :

If the current temperature is 18.8°C, default setting temperature is 27° required temperature is 30°C.



Current water temperature



Required water temperature

Useful information about how the silent mode operates

When the incoming water temperature is less than or equal to the required temperature (set point temperature) -X°C, the heat pump will switch to heating mode. The compressor will stop when the temperature of the incoming water is greater than or equal to the required temperature (set point temperature).

Temperature deviation value X setting

X : adjustable parameter from 1° to 18°C, default setting of temperature deviation value is 1°C. (Parameter "P01")

4.6 Auto mode

Step 1 : Press  to switch on your pump.

Step 2 : Press  to switch from one mode to another until the auto mode is displayed.



4. Use

4.7 Status values and advanced settings



WARNING: This operation is used to assist servicing and future repairs.
The default settings should only be modified by an experienced professional person.

The system's settings can be checked and adjusted via the control panel by following these steps

Step 1 : Keep pressing  5 second Until all three LEDs flash simultaneously.

Step 2 : Press  or  for select the parameters.

Step 3 : Press  for see the value .

Step 4 : Press  again to return selection parameters or Press  or  digital flashing.

Step 5 : Press  or  to adjust the setting value.

Note, some settings cannot be modified. Consult the settings table for further information.

Step 6 : Press  to set the new value.

Step 7 : Press  to return to the main screen.

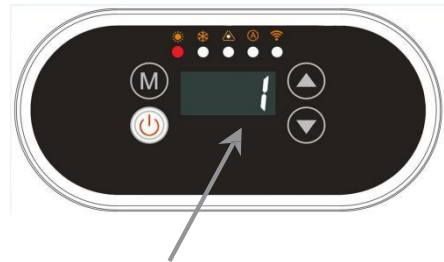

4. Use

4.7 Status values and advanced settings

Parameters table

N°	Description	Range value	Default value	Comment
P01	Adjustment of temperature difference for restart	1~18°C	1°C	Actual data
P02	Reserved	/	/	/
P03	Reserved	/	/	/
P04	Setting temperature in cooling mode	5~28°C	27°C	Adjustable
P05	Setting temperature in heating mode	25~45°C	27°C	Adjustable
P06	Discharge temperature protect value	80~125°C	115°C	Adjustable
P07	Discharge temperature recover value	50~100°C	95°C	Adjustable
P08	Compressor current protect	2-50A	Reserved	/
P09	Inlet water temperature compensation	50~100°C	95°C	Adjustable
P10	Reserved	/	/	/
P11	Defrosting mode activation timer	20-90 min	45 min	Adjustable
P12	Defrosting mode coil entry temperature	-15~-1°C	-3°C	Adjustable
P13	Defrosting mode maximum duration	5-20 min	8 min	Adjustable
P14	Defrosting mode coil exit temperature	1~40°C	20°C	Adjustable
P15	Defrost mode ambient and coil temperature difference	0~15°C	0°C	Adjustable
P16	Defrosting mode air entry temperature	0~20°C	17°C	Adjustable
P17	EEV activation timer	20-90 sec.	45 sec	Adjustable
P18	Heating mode suction super temperature set value	-5~10°C	Reserved	/
P19	EEV active - Discharge temperature protect	70~125°C	Reserved	/
P20	EEV opening - Defrosting mode	20~450	Reserved	/
P21	EEV minimum opening	50~150	Reserved	/
P22	EEV mode selection	0 = Manual 1 = Auto	Reserved	/
P23	EEV manual mode opening	20~450	Reserved	/
P24	Cooling mode suction super temperature set value	-5~10°C	Reserved	/
P25	Constant temperature mode Filtration pump stop time	1~99min	45 min	Adjustable
P26	Constant temperature mode Filtration pump running time	0~99min	5 min	Adjustable
P27	Cooling EEV working mode	0 = ambient temperature 1 = suction super temperature	Reserved	/
P28	Filtration pump working mode	0 = constant temperature stop 1 = constant temperature running	1	Adjustable
P29	Max water outlet temp set in heating mode	25~45°C	43°C	Adjustable

5. Operation

Operation

Conditions of use

For the heat pump to operate normally, the ambient air temperature must be between -20°C and 43°C.

Recommendations prior to start-up

Before activating the heat pump, please:

- ✓ Check that the unit is stable.
- ✓ Control the proper functioning of your electrical installation.
- ✓ Check that the hydraulic connections are tight and that there is no leakage of water.
- ✓ Remove any unnecessary object or tool from around the unit.

Operation

1. Connect the unit power plug.
2. Activate the circulating pump.
3. Activate the unit's power supply protection (differential switch and circuit-breaker).
4. Activate the heat pump
5. Select the required temperature.
6. The heat pump's compressor will start up after a few moments.

All you have to do now is wait until the required temperature is reached.



WARNING: Under normal conditions, a suitable heat pump can heat the water in a swimming pool by 1°C to 2°C per day. It is therefore quite normal to not feel any temperature difference in the system when the heat pump is working. A heated pool must be covered to avoid any loss of heat.

6. Maintenance and servicing

6. Maintenance, servicing and winter storage



WARNING: Before undertaking maintenance work on the unit, ensure that you have disconnected the electrical power supply.

Cleaning

The heat pump's casing must be cleaned with a damp cloth. The use of detergents or other household products could damage the surface of the casing and affect its properties.

The evaporator at the rear of the heat pump must be carefully cleaned with a vacuum cleaner and soft brush attachment.

Annual maintenance

The following operations must be undertaken by a qualified person at least once a year .

- ✓ Carry out safety checks.
- ✓ Check the integrity of the electrical wiring.
- ✓ Check the earthing connections.
- ✓ Monitor the state of the pressure gauge and the presence of refrigerant.
- ✓ It would be wise for heat pumps that are used on Ponds and non-Chemically treated Hot Tub users to flush out the titanium heat exchanger, every few months, as Bio-Film will build up here all depending on bather and fish loading. **N.B. Be careful of the water flow switch and anything electrical when doing this.**

Winter storage

Your heat pump is designed to operate in rainy weather conditions and withstand frost using a specially created anti-frost technology. However it is not recommended to leave it outside for long periods of time (e.g. over winter) whilst connected to water without flow. After draining down the pool for the winter, store the heat pump in a dry place and "FREE" from any trapped water that may freeze.

7. Repairs



WARNING: Under normal conditions, a suitable heat pump can heat the water in a swimming pool by 1°C to 2°C per day. It is therefore quite normal to not feel any temperature difference in the system when the heat pump is working.

A heated pool must be covered to avoid any loss of heat.

7.1 Breakdowns and faults

In the event of a problem, the heat pump's screen displays an error code instead of temperature indications. Please consult the table below to find the possible causes of a fault and the actions to be taken.

Fault code example

Fault code E09



7. Repairs

7.2 List of faults

Code	Fault	Possible causes	Action
E03	Flow sensor malfunction	Insufficient water in heat exchanger	Check your water circuit operation and the opening of the By-Pass valves
		Sensor disconnected or defective	Reconnect or replace sensor
E04	Antifreeze protection	Protection activated when the ambient temperature is too low and the unit is on standby	No intervention is necessary
E06	Low pressure protection	Insufficient refrigerant gas	Readjust the refrigerant volume
		Defective 4-way valve	Replace valve
		Low pressure switch disconnected or defective	Reconnect or replace low pressure switch
E09	Ambient temperature exceeds operating range	Ambient temperature sensor failure	Replace sensor
		Ambient temperature is too high or too low	Suggest to shut down the unit
		Defective PCB	Replace PCB
E10	Connection problem between PCB and inverter module	Bad connection	Check wiring connections between PCB and inverter module
		Defective inverter module	Replace inverter module
		Defective PCB	Replace PCB
E12	Vented air temperature too high	Insufficient refrigerant gas	Readjust the refrigerant volume
E13	Vented air temperature too low	Ambient temperature too low	Check the ambient temperature
		Sensor disconnected or defective	Reconnect or replace sensor
E15	Water intake temperature sensor malfunction	Sensor disconnected or defective	Reconnect or replace sensor
E16	Outside coil temperature error	Sensor disconnected or defective	Reconnect or replace sensor
E18	Vented temperature error	Sensor disconnected or defective	Reconnect or replace sensor
E20	Inverter module protection	See chapter Appendices	
E21	Ambient temperature error	Sensor disconnected or defective	Reconnect or replace sensor
E23	Water temperature at outlet too low for cooling mode	Insufficient water flow	Check water pump operation and openings of By-Pass inlet/outlet valves
E27	Water outlet error	Sensor disconnected or defective	Reconnect or replace sensor
E32	Outlet temperature too high for heating mode protection	Insufficient water flow	Check water pump operation and openings of By-Pass inlet/outlet valves
E33	Coil temp too high (higher than 60°C) for cooling mode protection Too great a difference between the inlet water temperature and the outlet water temperature	Refrigerant overcharged	Readjust the refrigerant volume
		Fan motor doesn't work or air outlet blocked	Check the fan is working properly and the air inlet is unobstructed
		Insufficient water flow	Check the good circulation of water in the heat pump, and the opening of the inlet / outlet valves of the By-Pass
		Sensor disconnected or defective	Reconnect or replace sensor
E46	DC fan motor malfunction	Bad wire connection	Reconnect the fan
		Fan motor is defective	Replace the fan motor

8. Recycling

8. Recycling the heat pump

Your heat pump has reached the end of its life and you wish to dispose of it or to replace it. Do not throw it in the rubbish bin.

A heat pump must be disposed of separately with a view to its reuse, recycling or upgrading. It contains substances that are potentially hazardous to the environment but which will be eliminated or neutralized by recycling.

YOU HAVE THREE SOLUTIONS:

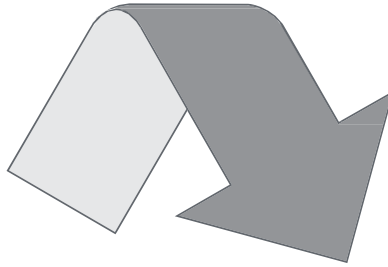

①

Disposing of it at your local recycling centre

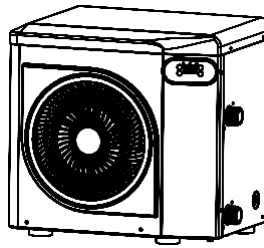

②

Giving it to a social service organization for it to be repaired and put back into circulation.

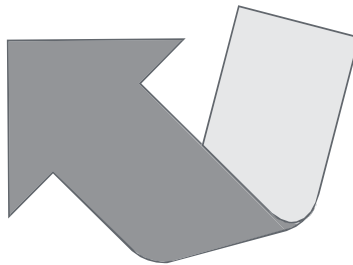

A. Appendices

A.1 Wiring diagrams

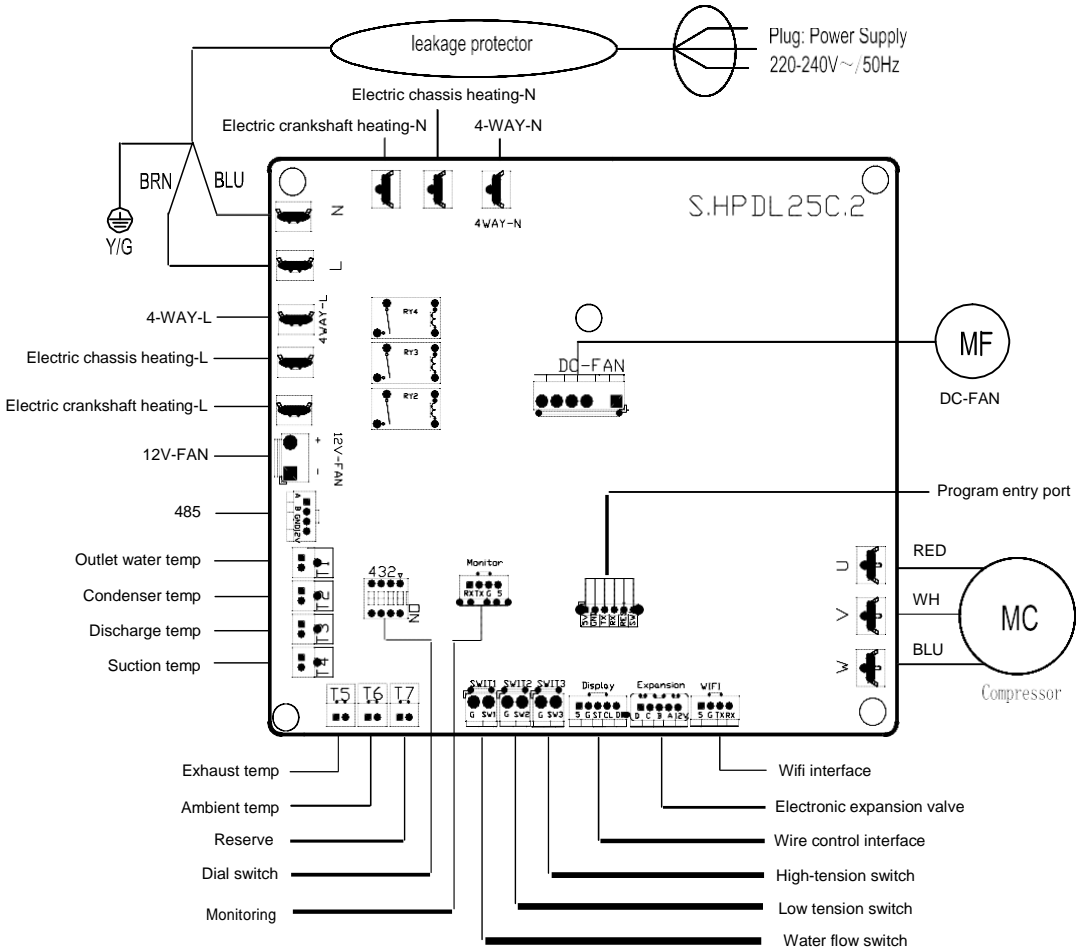



01 / 2021
